

SWIRE COCA-COLA'S MANUFACTURING JOURNEY

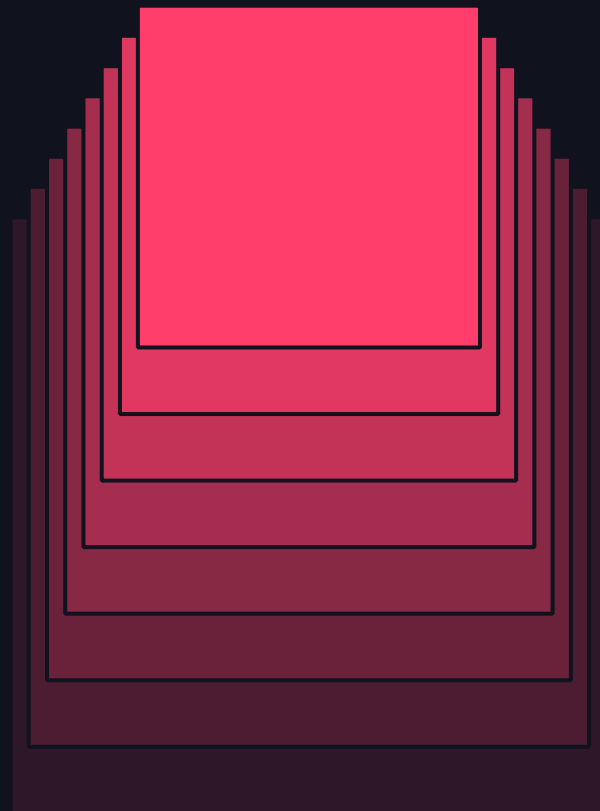

Bharathi Rajan
13 June 2024



Speaker info

- Bharathi Rajan, VP– Enterprise Data

 brajan@swirecc.com

<https://www.linkedin.com/in/bharathirajan/>

- Sudhir Arni - SVP, Business Outcomes

 sarni@sightmachine.com

<https://www.linkedin.com/in/sudhirarni/>

Who is Swire Coca-Cola, USA?

- <https://www.youtube.com/watch?v=44wEOACEIVw>



Swire Coca-Cola, USA

Coca-Cola's Fifth Largest Bottling Partner

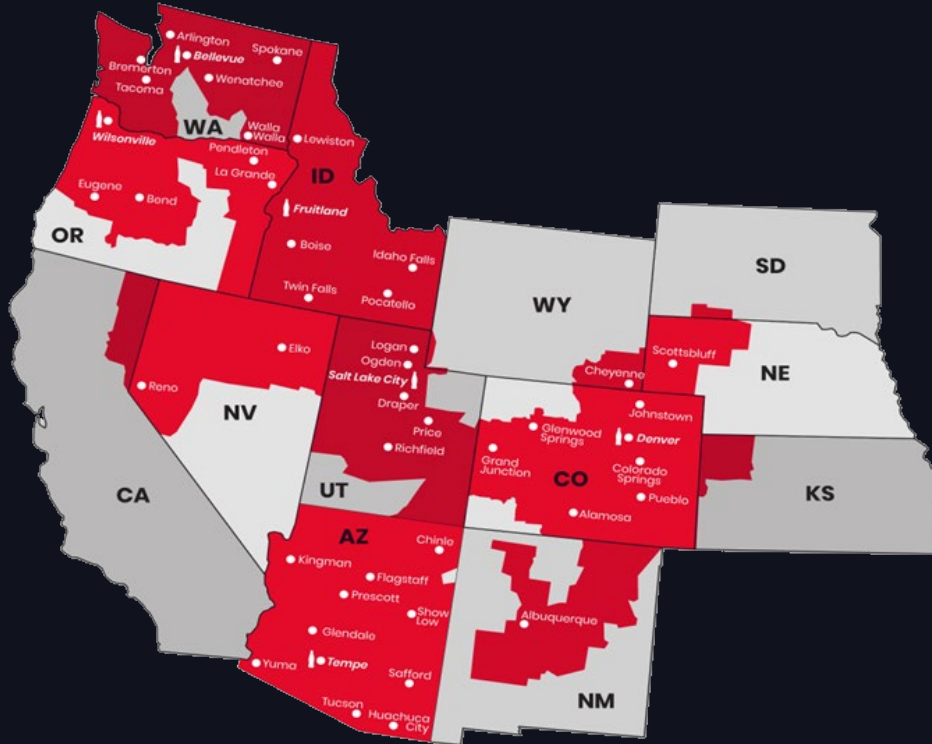

50+ Brands
250+ Products
6 Production Plants
63 Distribution Centers
~2K Trucks

Swire Coca-Cola, USA

Coca-Cola's Fifth Largest Bottling Partner

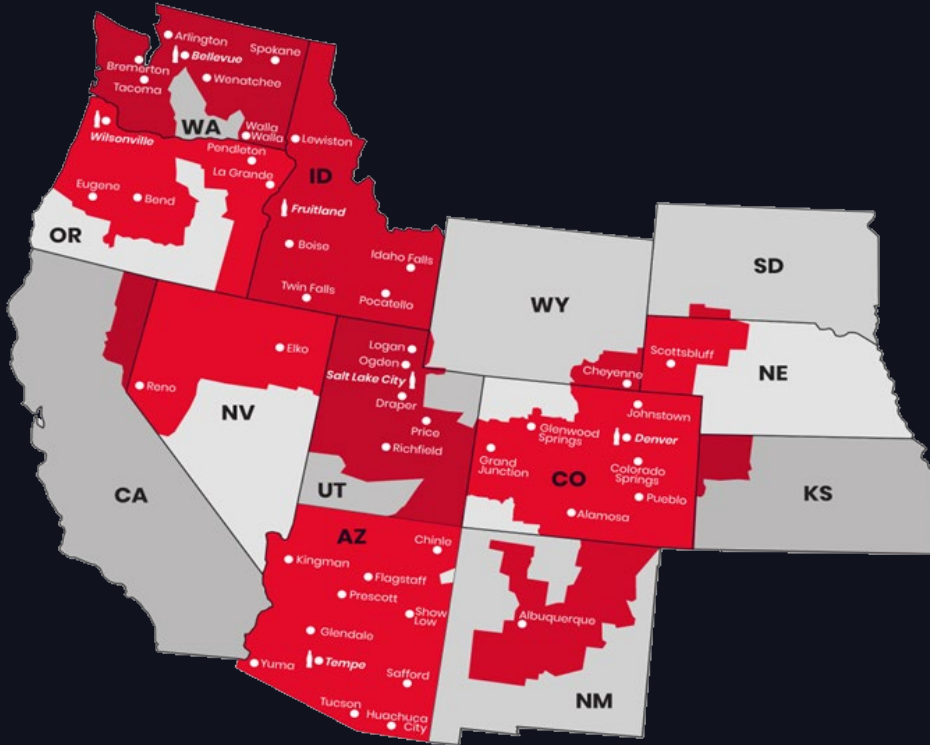

194M+ Volume

31M Consumers

~20K Retail Outlets

51K FSOP Outlets

186K Coolers & Vending

Manufacturing Process – High scale, Low tech

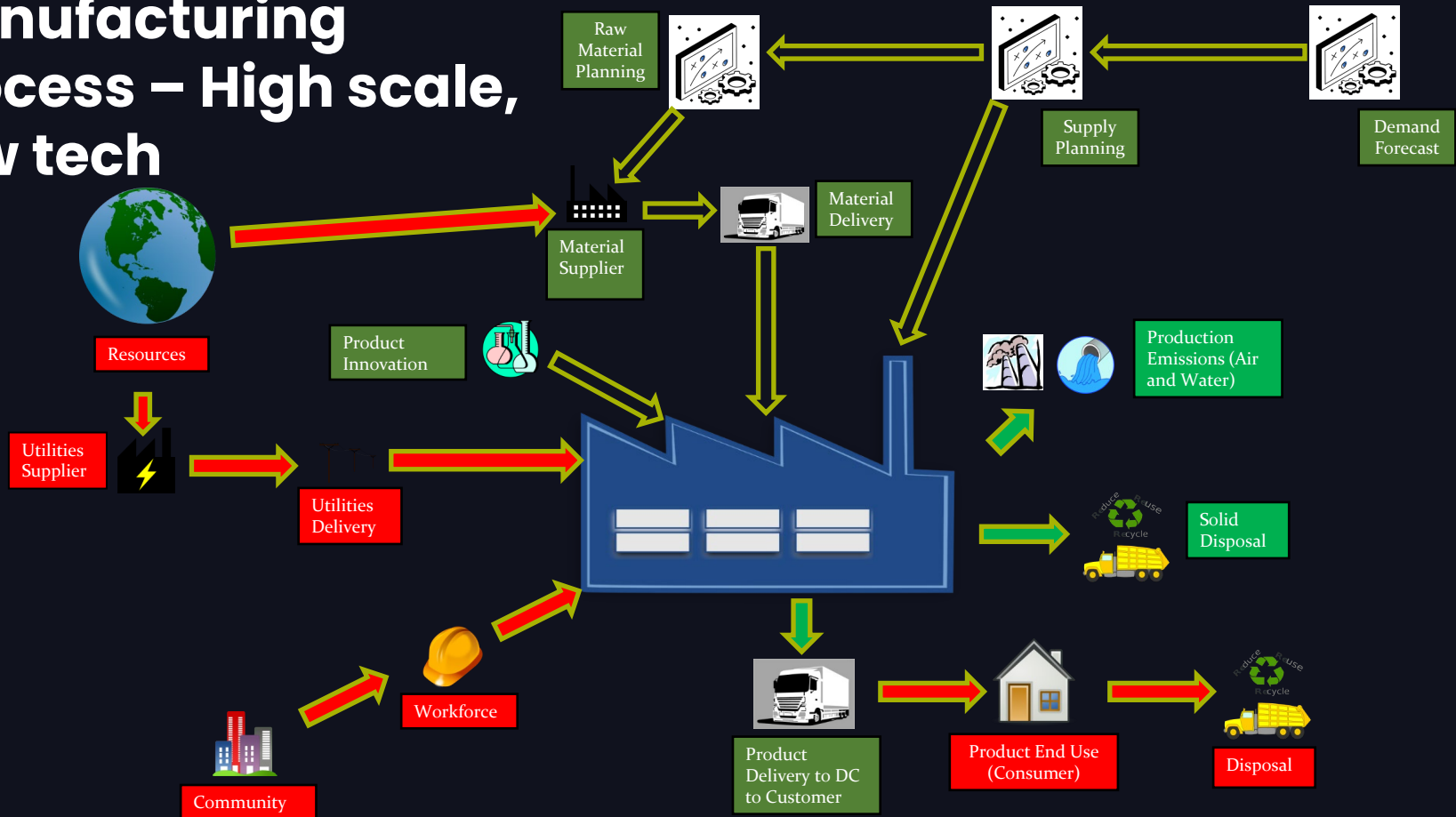

Production Flow Chart

PRODUCTION PROCESS MODEL

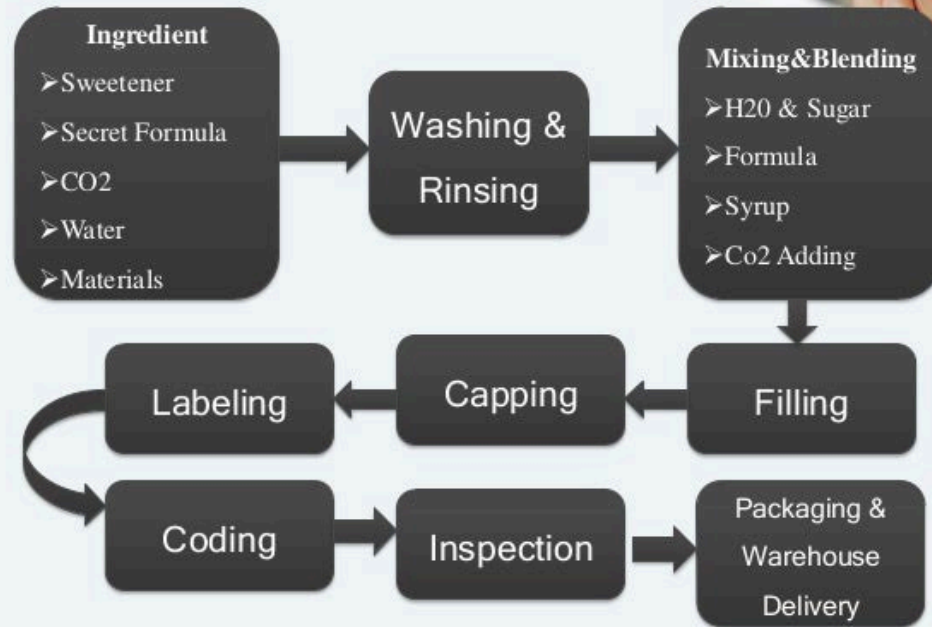

Manufacturing Process - Plant floor

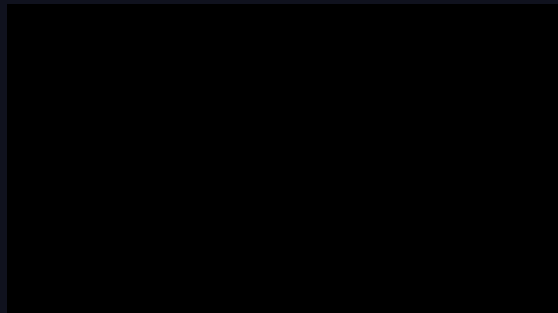

8

8



Core Business Challenges

What is preventing us from achieving greater efficiencies?



People & Systems

Legacy systems, dependency on internal expertise & an aging workforce create significant risk for the business.

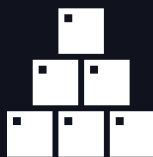

Input Materials

Challenges with demand prediction and being able to acquire sufficient inputs to meet that demand limit our capacity.



Shopfloor Data

Lack of insights into production line status makes it difficult to keep the lines running at critical intervals.



Core Business Challenges

People & Systems



Multiple, legacy systems

Minimal integration between legacy systems

Delayed decision making due to lack of or outdated data



Aging workforce

retirement and loss of knowledge



Copy-of-copy effects

Hands-on skills training



Core Business Challenges Systems

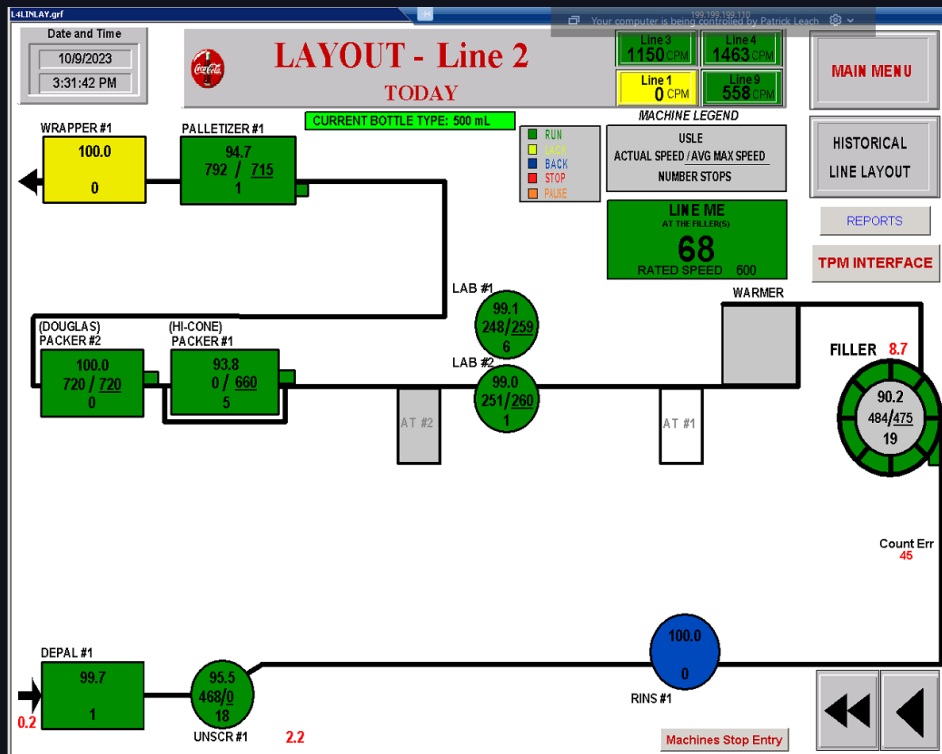

- Originally built – 2000
- Custom built for each plant
- **2010 – rebuilt with consistency across each plant,**
- **USLE vs Mechanical efficiency**
- **Not user friendly**
- **Changes not easy to make in the system due to change and complexity**
- **Hardware/software tightly coupled**
- **PLC to communicate**
- **Stationary system**
- **Plant based system**



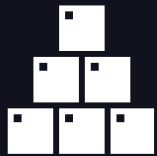

Core Business Challenges

Input/Raw Materials



Demand signals

Overstocking vs. shortages



Material variations

Production schedules

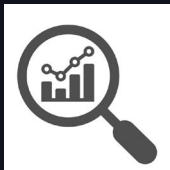

Core Business Challenges

Data

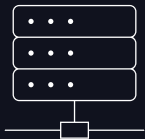

Contextualization of data

Minimal or No understanding of sensor data



Cost & Yield data

Cost correlation



Line faults





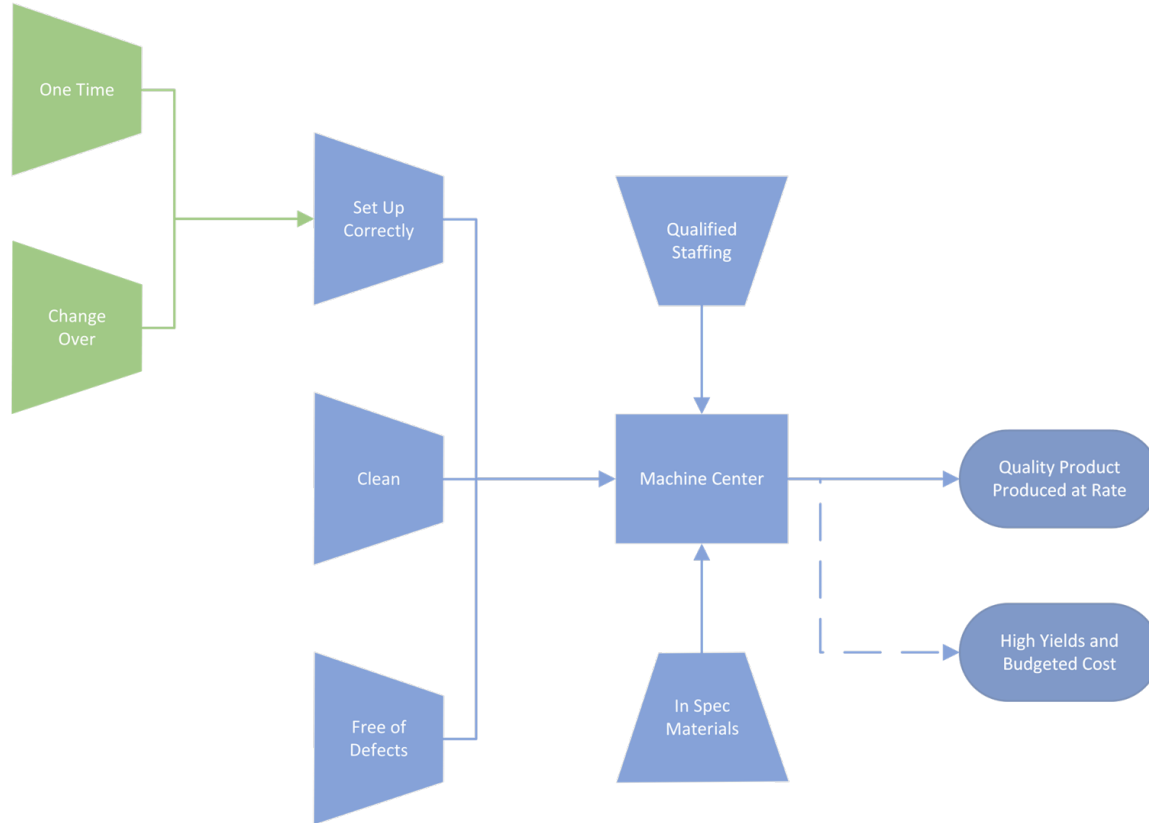



Descriptive text here

Manufacturing Process – Future state – Plant level



MACHINE: TIME: PLANNED / UNPLANNED: FAULT REASON: ACCEPTED:

EDIT

<input type="checkbox"/>	Duration hh:mm:ss	Start Time	End Time	Fault Reason	Downtime Reason		
<input type="checkbox"/>	00:34:49	Jun. 3, 2024 22:19:22	Jun. 3, 2024 22:54:11	LACK	SELECT UPSTREAM MACHINE		ACCEPT
<input type="checkbox"/>	00:15:50	Jun. 3, 2024 21:41:15	Jun. 3, 2024 21:57:05	LACK	SELECT UPSTREAM MACHINE		ACCEPT
<input type="checkbox"/>	00:45:22	Jun. 3, 2024 20:50:02	Jun. 3, 2024 21:35:24	LACK	SELECT UPSTREAM MACHINE		ACCEPT
<input type="checkbox"/>	00:58:01	Jun. 3, 2024 19:47:32	Jun. 3, 2024 20:45:34	LACK	SELECT UPSTREAM MACHINE		ACCEPT
<input type="checkbox"/>	00:20:38	Jun. 3, 2024 18:58:53	Jun. 3, 2024 19:19:31	LACK	SELECT UPSTREAM MACHINE		ACCEPT
<input type="checkbox"/>	00:00:21	Jun. 3, 2024 18:55:22	Jun. 3, 2024 18:55:43	LACK	SELECT UPSTREAM MACHINE		ACCEPT
<input type="checkbox"/>	00:22:30	Jun. 3, 2024 18:32:09	Jun. 3, 2024 18:54:40	LACK	SELECT UPSTREAM MACHINE		ACCEPT
<input type="checkbox"/>	00:12:53	Jun. 3, 2024 17:50:11	Jun. 3, 2024 18:03:05	LACK	SELECT UPSTREAM MACHINE		ACCEPT

FACILITY

DOWNTIMES



Today

RESET

ME
100.0%

MTBF
0.000

Cases Produced
4404

Product SKU
**CLASSIC
COKE 228 0.5L**

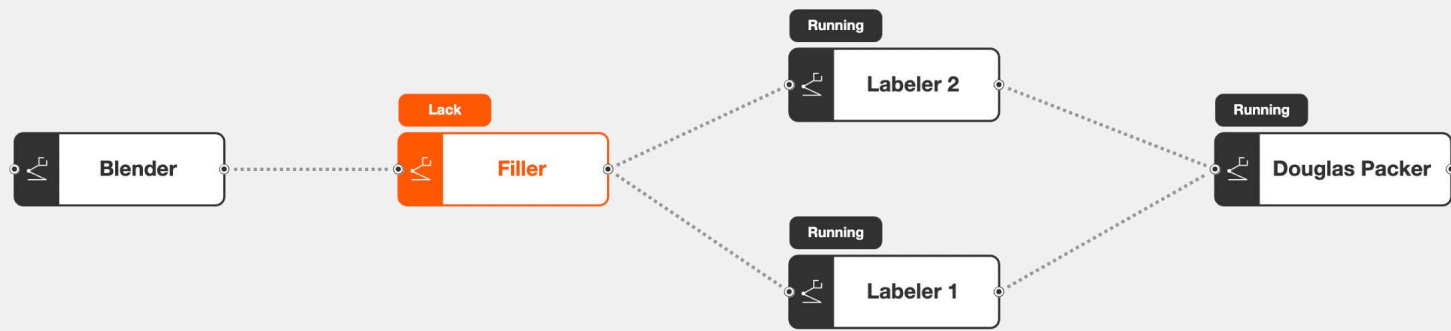

Blender	
Curr. Speed	0.000
Avg. Speed	120.1

Filler	
Curr. Speed	0.000
Avg. Speed	119.5
Efficiency	100.0%
MTBF	0.000

Labeler 1	
Curr. Speed	50.96
Avg. Speed	74.74

Labeler 2	
Curr. Speed	50.95
Avg. Speed	61.73

Douglas Packer	
Curr. Speed	624.0
Avg. Speed	220.0
Efficiency	53.35%

FACILITY DOWNTIMES



Frontline workforce will be empowered to engage easily with manufacturing data for decision making



- ✓ Empower
- ✓ Train
- ✓ Guide
- ✓ Advise remotely
- ✓ Maintain and fix with AI co-pilots

High Level System Architecture for OERSC USA Production Center

Based on Siemens Industrial Edge w/IIH + Sight Machine + Azure Cloud

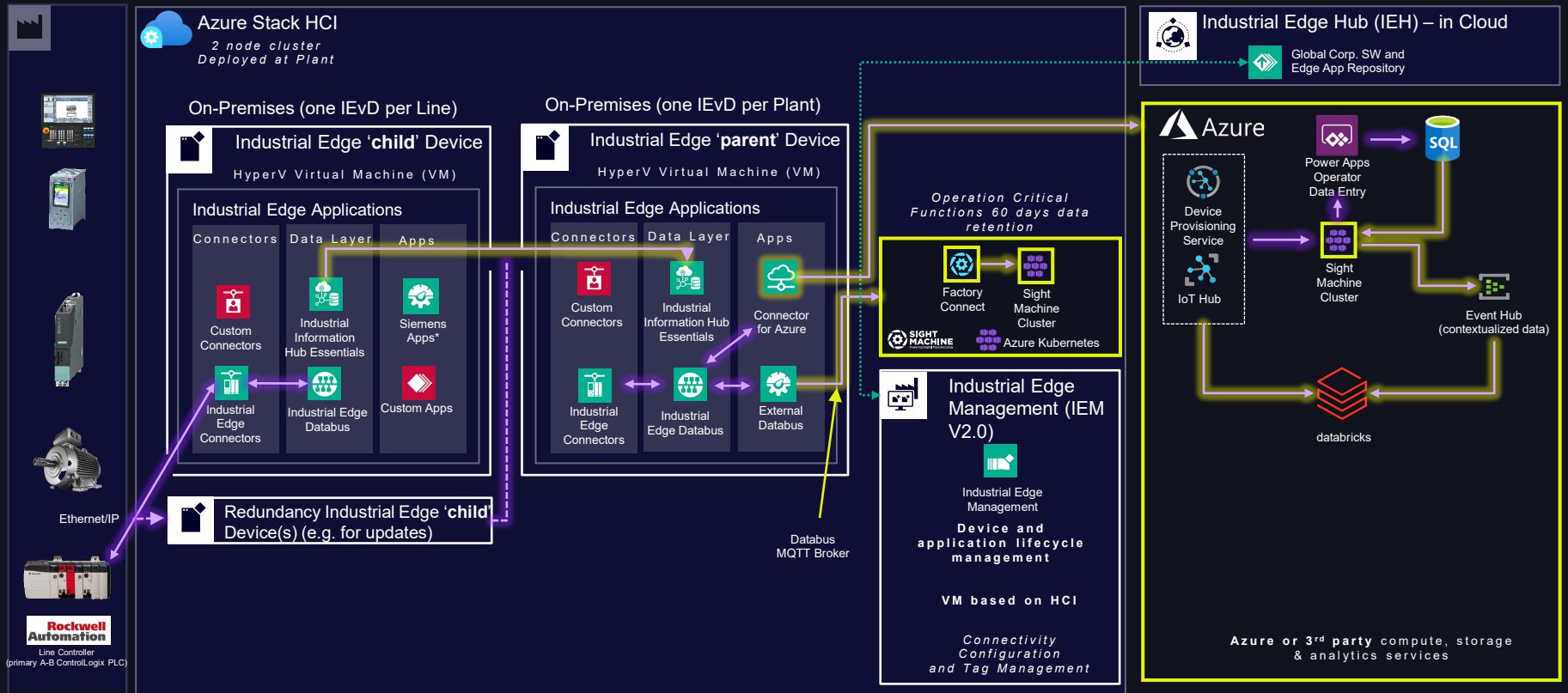

*Siemens Apps in scope: WinCC Unified for Edge, Notifier Edge App, Performance Insight, Flow Creator

Sight Machine's structured plant data is available for Databricks users to build analytics for the enterprise



Sight Machine Connector for Databricks





Core Business Challenges revisited

Bringing in efficiencies





People & Systems

-  Legacy Systems
-  Aging workforce
-  Copy-of-copy effects





Input Materials

-  Demand Signal
-  Material variations



Shopfloor Data

-  Contextualization
-  Costs
-  Line Faults

Questions?

- Bharathi Rajan, VP– Enterprise Data

 brajan@swirecc.com

<https://www.linkedin.com/in/bharathirajan/>

- Sudhir Arni - SVP, Business Outcomes

 sarni@sightmachine.com

<https://www.linkedin.com/in/sudhirarni/>

Contact

- Bharathi Rajan, VP– Enterprise Data

 brajan@swirecc.com

<https://www.linkedin.com/in/bharathirajan/>



- Sudhir Arni - SVP, Business Outcomes

 sarni@sightmachine.com

<https://www.linkedin.com/in/sudhirarni/>